

## Pressure Switch Modular Valves

### Specifications

Model Numbers	Max. Operating Pressure MPa(Psi)	Max. Flow L/min (U.S.GPM)
MJ*-01-M-*-*-10	31.5 (4570)	35 (9.25)
MJ*-01-J-35-10	10 (1450)	
MJ*-01-J-100-10	10 (1450)	
MJ*-01-J-200-10	20 (2900)	
MJ*-01-J-350-10	35 (5080)	

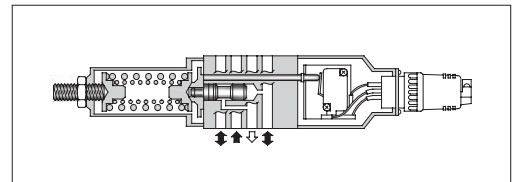
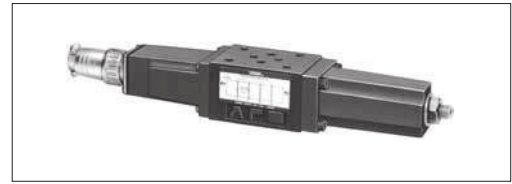

### Sensitive Switch Ratings

Electric Source		AC	DC	
Voltage	V	125 • 250	125	250
Current	A	11A-1/3HP	0.5	0.25

### Specifications of semiconductor type pressure switch

JT-02 series is installed for semiconductor type pressure switch, refer to page 272 for details.

### Model Number Designation

F-	MJP	-01	-M	-B	-N	-10	*
Special Seals	Series Number	Valve Size	Type of Switch	Pres. Adj. Range MPa (PSI)	Type of Electrical Connection	Design Number	Design Standard
<b>F:</b> Special Seals for Phosphate Ester Type Fluids (Omit if not required)	<b>MJP :</b> Pressure Switch for P-Line	<b>01</b>	<b>M:</b> Sensitive Switch	<b>B:</b> 1-7 (145-1020) <b>C:</b> 3.5-14 (510-2030) <b>H:</b> 7-21 (1020-3050)	<b>None:</b> Cable Connector Type <b>N:</b> With Plug-in Connector (DIN)	<b>10</b>	Refer to ★
	<b>MJA :</b> Pressure Switch for A-Line		<b>J:</b> Semi-conductor Type Pressure Switch	<b>35:</b> 0.1-3.5 (14.5-510) <b>100:</b> 1-10 (145-1450) <b>200:</b> 2-20 (290-2900) <b>350:</b> 3.5-35 (510-5080)	<b>None:</b> Lead Wire Type		
<b>MJB :</b> Pressure Switch for B-Line							

★ Design Standards: None ..... Japanese Standard "JIS", European Design Standard and N. American Design Standard

### Graphic Symbols

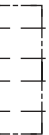
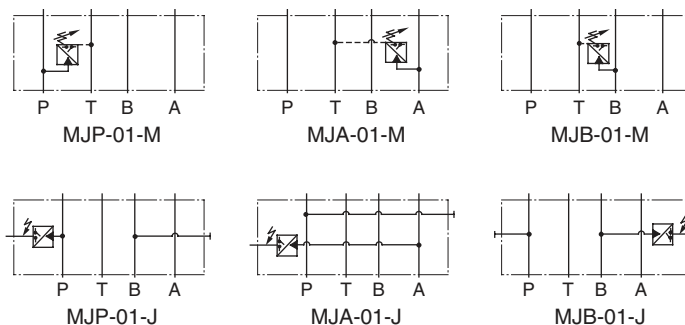

**Instructions**

- To make pressure adjustment, loosen the lock nut and turn the pressure adjustment screw clockwise or anti-clockwise. For an increase of pressure, turn the screw clockwise. Be sure to re-tighten the lock nut firmly after making adjustment to the pressure.
- Wiring of a sensitive switch should be made correctly referring to the table below. Numbers in the switch status column indicate wiring numbers in receptacles or contact numbers of connectors.

( Pressure with Sensitive Switch )  
and The Switch Status

Operating Pressure	Switch Status
Less than Pressure setting	1 ○ 2 ○ 3
More than Pressure setting	1 ○ 2 ○ 3

**Attachment**

Valve Model No.	Attachment
MJ*-01-M-*-10	Cable connector: NJC-203-PR ..... 1 Pc.
MJ*-01-M-*-N-10	DIN connector: GDM311-B-11... 1 Pc.

**Pressure Drop**

Hydraulic Fluid: Viscosity 35 mm<sup>2</sup>/s (164 SSU), Specific Gravity 0.850

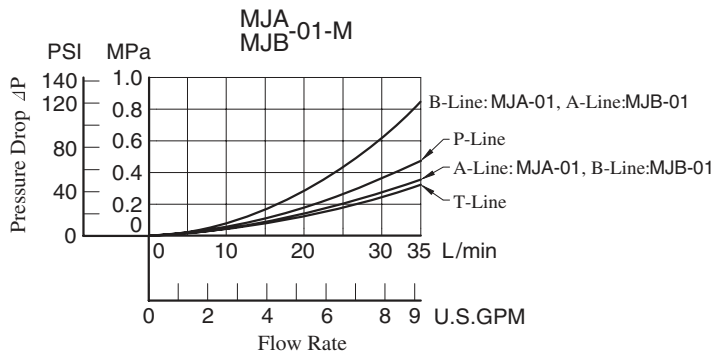
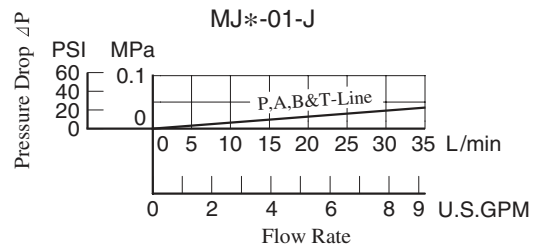
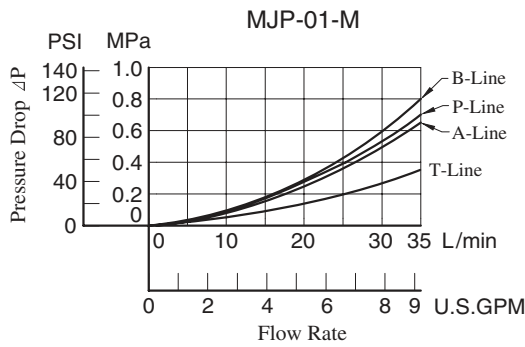

## ● Cable Connector Type

MJP-01-M-\*-10

MJA-01-M-\*-10

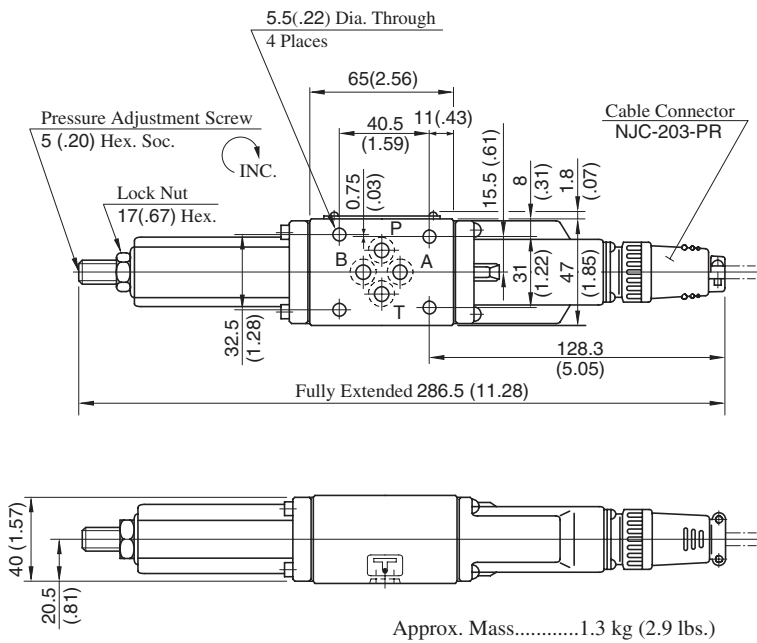

## MJB-01-M-\*-10

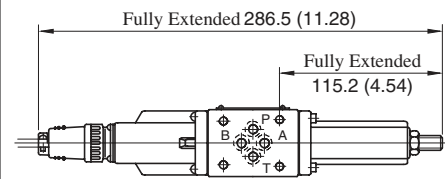

Approx. Mass.....1.3 kg (2.9 lbs.)

- For other dimensions, refer to "MJ<sub>A</sub><sup>P</sup>-01" drawing left.

## ● Plug-in Connector Type

MJP-01-M-\*-N-10

MJA-01-M-\*-N-10

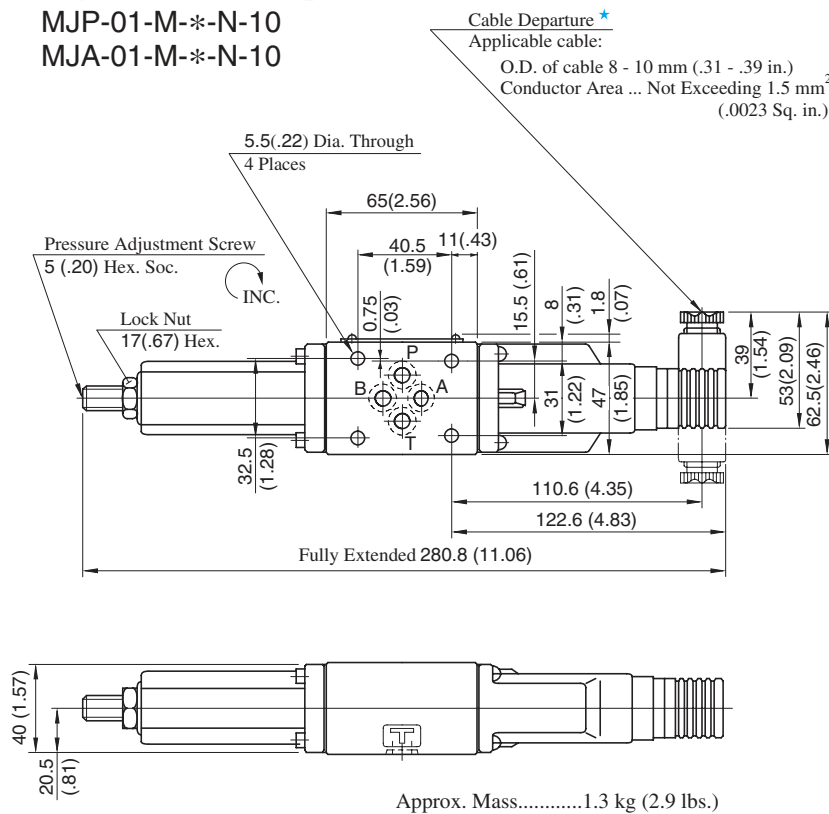

DIMENSIONS IN  
MILLIMETRES (INCHES)

## MJB-01-M-\*-N-10

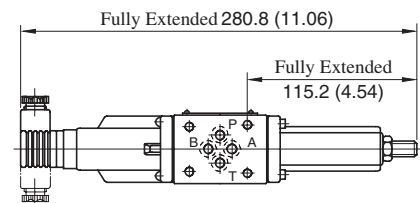

Approx. Mass.....1.3 kg (2.9 lbs.)

- For other dimensions, refer to "MJ<sub>A</sub><sup>P</sup>-01" drawing left.

★ As shown by the dot-and-dash line, the cable departure can also be faced opposite.



01 Series Modular Valves

● **Semiconductor Type Pressure Switch**

MJP-01-J-\*-10  
MJA-01-J-\*-10

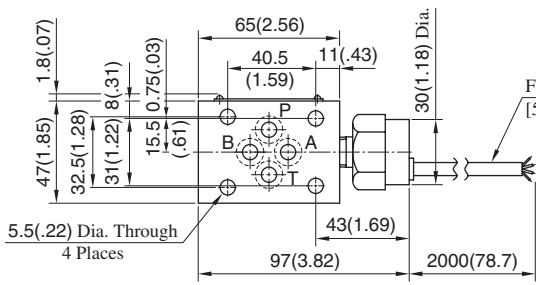

Four Conductor Cable  
[5 mm(.20 in.) O.D.]  
RED-----Power Supply ⊕  
BLACK---Power Supply ⊖  
WHITE---Output ⊕  
GREEN---Output ⊖

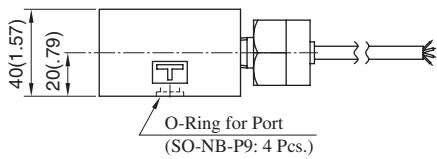
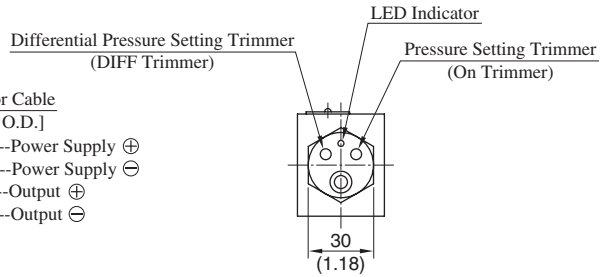

Approx. Mass.....1 kg (2.2 lbs.)

**MJB-01-J-\*-10**

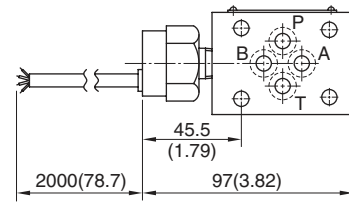

Approx. Mass.....1 kg (2.2 lbs.)

● For other dimensions, refer to "MJ<sub>A</sub><sup>P</sup>-01" drawing left.

■ **Spare Parts List**

● **Plug-in Connector Type**

MJP  
MJA-01-M-\*-N-10  
MJB

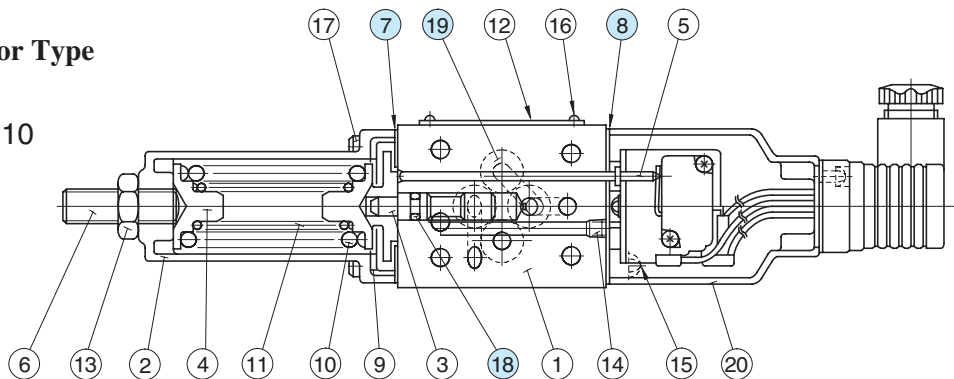

● **Cable Connector Type**

MJP  
MJA-01-M-\*-10  
MJB

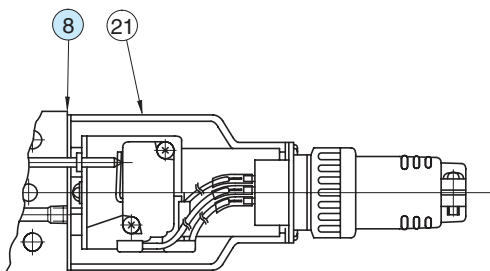

● **List of Seals**

Item	Name of Parts	Part Numbers	Qty.
7	Packing	3116-VK414239-4	1
8	Packing	3116-VK414240-2	1
18	O-Ring	SO-NA-P5	1
19	O-Ring	SO-NB-P9	4

Note: When ordering seals, please specify the seal kit number from the table below.

● **List of Seal Kits**

Valve Model No.	Seal Kit Numbers
MJP-01	Included in seal kit Kit No.: KS-MJP-01-10
MJA-01	
MJB-01	

● Since MJ\*-01-J-\*-10 (Semiconductor type pressure switch) does not have any seals inside, only four(4) O-rings for the ports are required. Please refer to the above drawing.